







Dati Tecnici / Données techniques

	Motore / Moteur	Benzina / Essence	Honda GX 270 9hp
	Trasmissione / Transmission	Tipo / Type	Idrostatica / hydrostatique
		Pompa idraulica / Pompe hydraulique	2x port.variabale / 2x engrenages planétaires
	Impianto idraulico / Plomberie	Pompa idraulica / Pompe hydraulique	Pompa a Ingranaggi / Pompe à engrenages
		Flusso Std / Flux Std	1x13.5 l/min (1x3.6 gpm)
		Flusso Hi-Flow / Flux Hi-Flow	1x22 l/min (1x5.8 gpm) ¹
		Pressione massima / Pression maximale	150 bar (2180 psi)
	Sottocarro cingolato / Châssis	Larghezza Cingoli / Largeur de chenilles	180 mm (7.1 in)
		Rulli oscillanti / Roulements à rouleaux	Si / Oui
	Prestazioni e dimensioni / Performances et dimensions	Velocità / Vitesse de déplacement max	0-4.5 Km/h (0-2.8 mph)
		Capacità operativa / Capacité opérationnelle	650 Kg (1432 lb)
		Peso / Poids	430 kg (992lb) ² < - > 500 kg (1102lb) ³ < - > 630kg (1389lb) ³
		Cassone Dumper / Caisson basculant	1150 x 800 x 350 mm (45.3x31.5x13.8 in) ³
		Cassone Dumper / Caisson basculant	1150 x 680 x 350 mm (45.3x26.8x13.8 in) ³
		Cassone Agricolo / Caisson Agricoles	1100 (1350 max) x800 (1300 max) mm x 250 mm ⁵
		Cassone Agricolo / Caisson Agricoles	43.3 (53.1 max) in x 32.5 (51.2 max) in x 9.8 in ⁵

1) Accessori / A la demande 2) Standard 3) Autocaricante / Bras auto chargeur
4) Versione scarico alto / Modèle avec dechargeur hauteur 5) Solo Std / Seulement Std

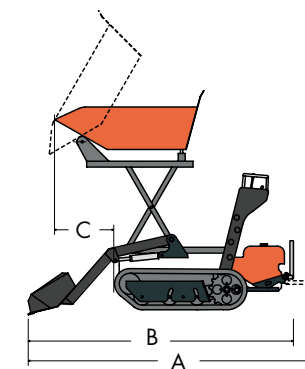
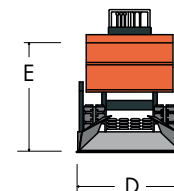

	mm	in
(A)	2640	103,94
(B)	2340	92,13
(C)	630	24,8
(D)	850	33,46
(E)	1100	43,31